

<b>NEI</b>	<b>Work Instruction</b>		Page 1 of 14
Title: <b>Unit Disassembly for WEEE</b>			
Document Number / Disk File: 597-786-1200-00	By: Jegan Easwaram	Current Rev: 0A	Date: 12/27/11
Assemblies Covered: <b>S-1200R3 (786-1200-00/01/02)</b>			



Revision	Date	ECO #	Revised By	Description of Changes
0A	12/27/11		Jegan Easwaram	Original Release

**Tools Required:**

- #2 Phillips Screwdriver
- #1 Phillips Screwdriver
- Wire Cutters (Use where needed to cut wire ties)
- 8mm Hex Nutdriver

<b>NEI</b>	<b>Work Instruction</b>		Page 2 of 14
Title: <b>Unit Disassembly for WEEE</b>			
Document Number / Disk File: 597-786-1200-00	By: Jegan Easwaram	Current Rev: 0A	Date: 12/27/11
Assemblies Covered: <b>S-1200R3 (786-1200-00/01/02)</b>			

**NOTE: Disconnect any AC Power Cords attached to the power supplies before disassembly of the unit.**

*Images shown are representative of product and may vary depending on actual configuration.*

1. Removal of the power cord does not require any tools  
 a. Remove the power cord first.

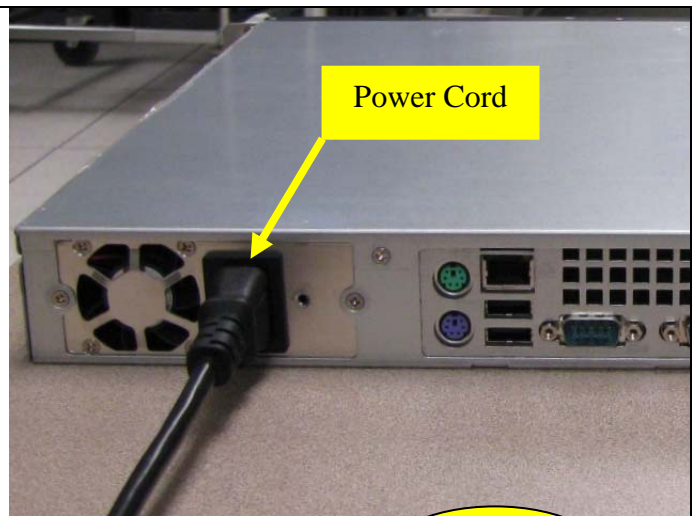

2. Removal of the top access cover needs a #2 screwdriver.  
 a. Remove the 2 screws from the side.  
 a. Press the two release buttons on the chassis cover and slide it towards the rear about an inch.  
 b. Remove access cover by lifting it up.  
**d. Discard sheet metal cover in appropriate recycle bin.**

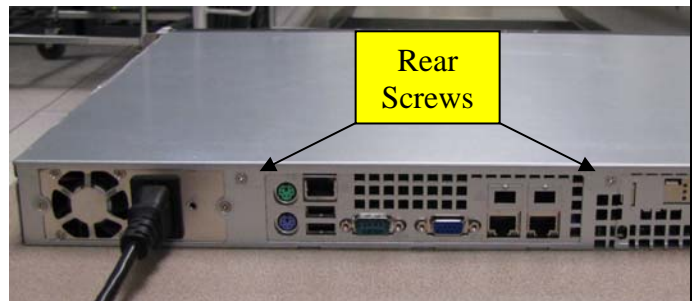
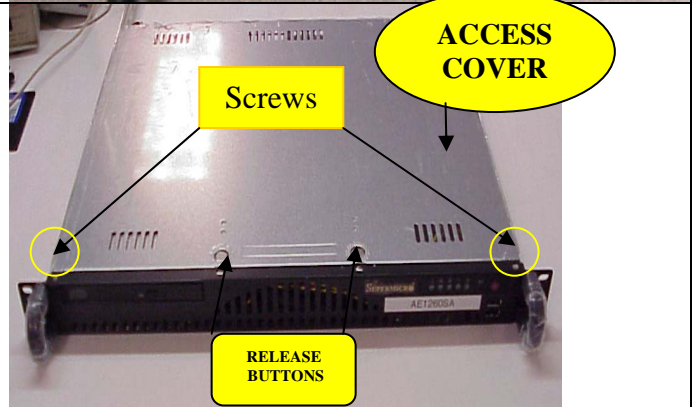

<b>NEI</b>	<b>Work Instruction</b>		Page 3 of 14
Title: <b>Unit Disassembly for WEEE</b>			
Document Number / Disk File: <b>597-786-1200-00</b>	By: <b>Jegan Easwaram</b>	Current Rev: <b>0A</b>	Date: <b>12/27/11</b>
Assemblies Covered: <b>S-1200R3 (786-1200-00/01/02)</b>			

3. Removal of the rails (if present) requires a #2 Phillips screwdriver.
- Remove the six side screws, 3 on each side, to remove rails.
  - Discard the metal rails and screws into the appropriate recycle bin.**

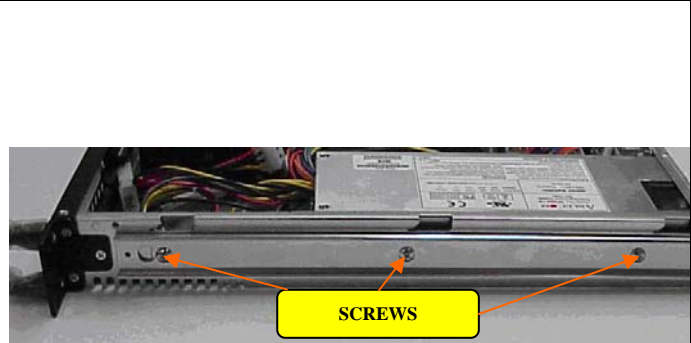

4. Removal of the PCI Riser and attached card does not require any tools.
- Push the locking tab and pull it up to remove it.
  - Remove the PCI Riser and any attached card by wiggling and then pulling it out.
  - Discard the PCI Riser and any attached card into the appropriate recycle bin.**

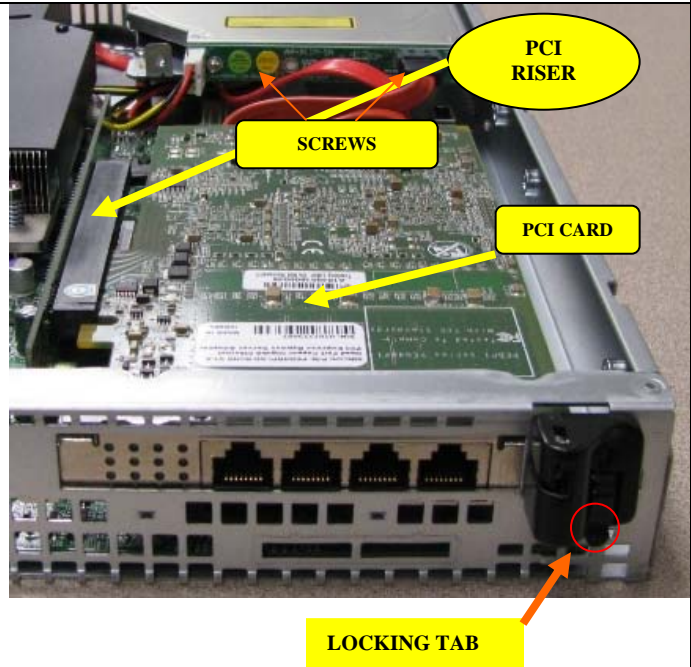

<b>NEI</b>	<b>Work Instruction</b>		Page 4 of 14
Title: <b>Unit Disassembly for WEEE</b>			
Document Number / Disk File: <b>597-786-1200-00</b>	By: Jegan Easwaram	Current Rev: 0A	Date: 12/27/11
Assemblies Covered: <b>S-1200R3 (786-1200-00/01/02)</b>			

5. Removal of the shroud and the fan assembly do not require any tools.

- a. Remove the shroud by pulling it out.
- b. Pull the fan power connectors out of the main board.
- c. Pull the fan out of the chassis

**d. Discard the shroud and fan into the appropriate recycle bin.**

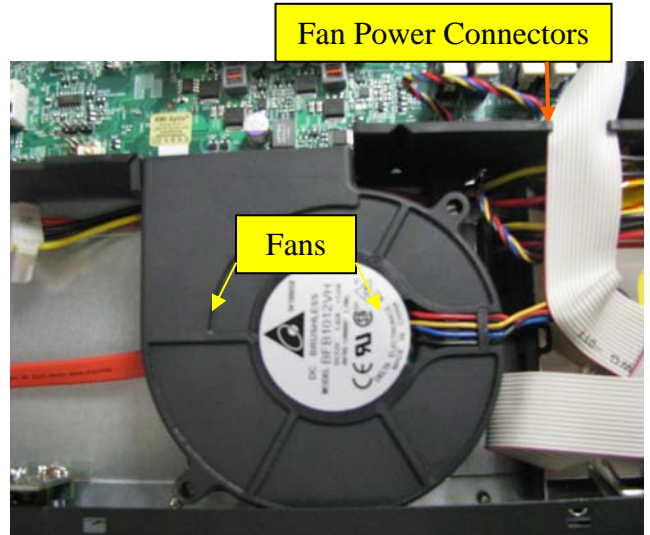
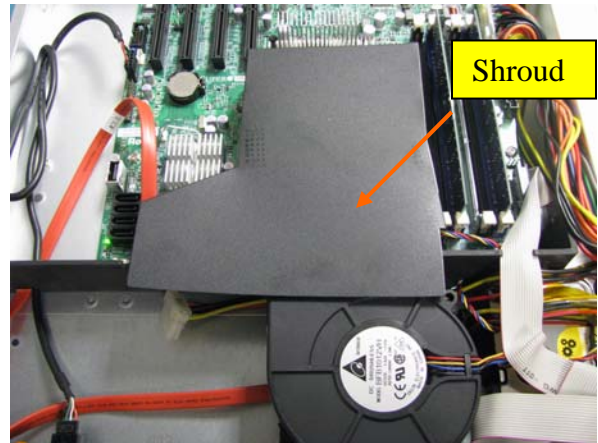

6. Removal of the DVD-ROM (if present) requires a #2 Phillips screwdriver.

- a. Unplug the data cable and the power cable.
- b. Remove the one screw from the top of the DVD-ROM bracket
- c. Remove a second screw from the left side of the DVD-ROM and pull the DVD-ROM towards the rear of the unit and pull it out to complete the removal.

**d. Discard the Screws into the appropriate recycle bin.**

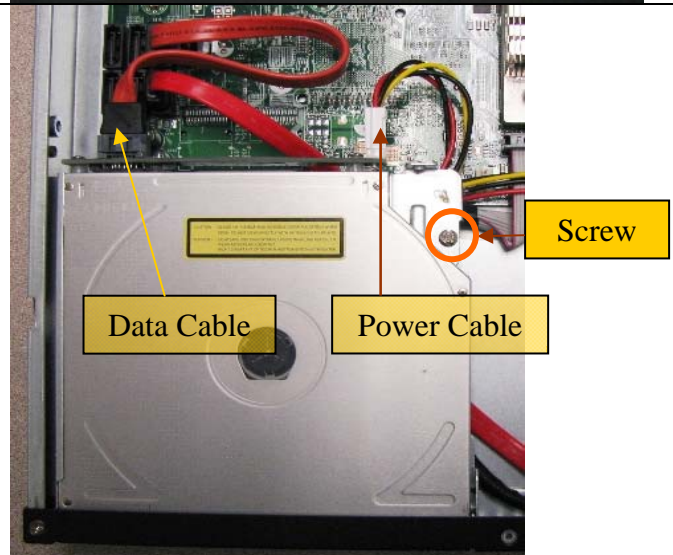

Title:

Unit Disassembly for WEEE

Document Number / Disk File:  
597-786-1200-00

By:  
Jegan Easwaram

Current Rev:  
0A

Date:  
12/27/11

Assemblies Covered:

S-1200R3 (786-1200-00/01/02)

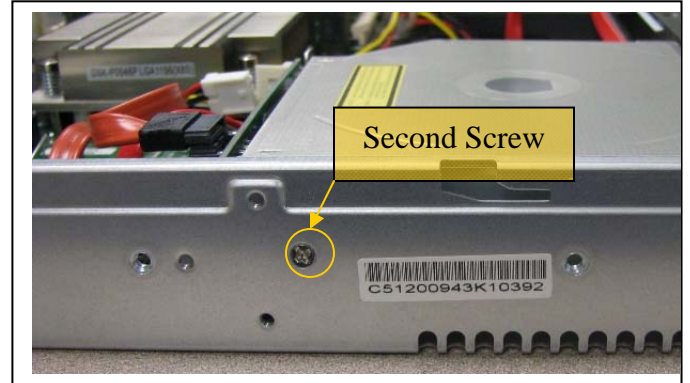

- 7. Removal of the DVD Adapter PCB from the DVD-ROM (if present) requires a #2 screwdriver. Removal of the DVD-ROM from the mounting plate requires a #0 Phillips Screw driver.
  - a. Remove the two screws to complete the removal of the PCB board.
  - b. Remove 4 screws that secure the DVD-ROM to the mounting plate.
  - c. **Discard the screws, PCB, mounting plate and the DVD-ROM into the appropriate recycle bin.**

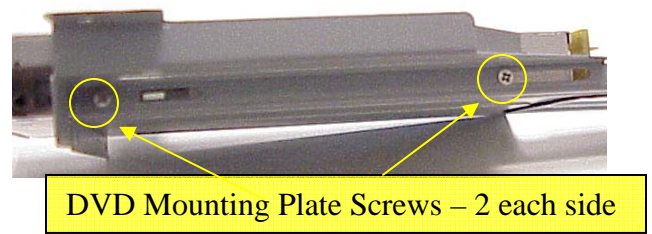

Title:

**Unit Disassembly for WEEE**

Document Number / Disk File:

597-786-1200-00

By:

Jegan Easwaram

Current Rev:

0A

Date:

12/27/11

Assemblies Covered:

**S-1200R3 (786-1200-00/01/02)**

8. Disconnect all connections to the motherboard.
- Disconnect all the power cables from the motherboard and hard drive
  - Disconnect drive data cables connected to the motherboard.
  - Disconnect the front panel cable.
  - Remove all disconnected cables from the unit.
- h. Discard the cables into the appropriate recycle bin.**

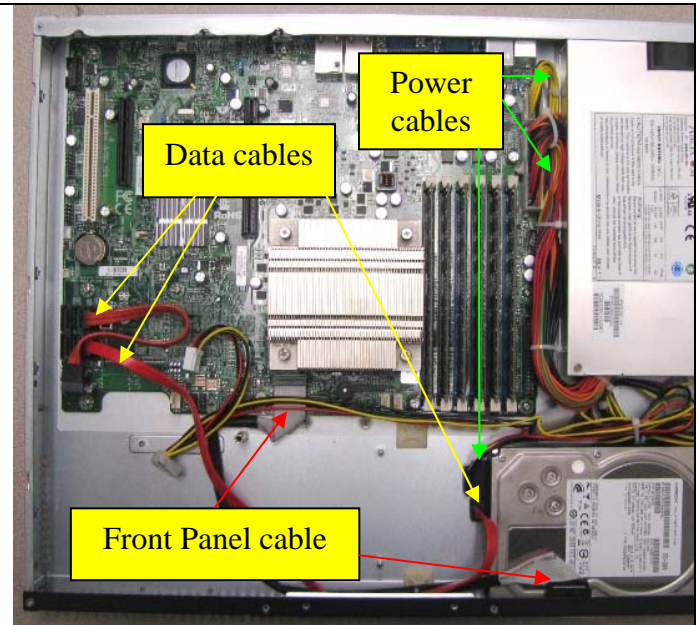

9. Removal of the Heat Sink requires a #2 Phillips screwdriver.
- Unscrew each of the 4 screws on the corners of the heat sink.
  - Pull the Heat Sink upwards to remove it, exposing the CPU.
- c. Discard the Heat Sink into the appropriate Recycle Bin.**

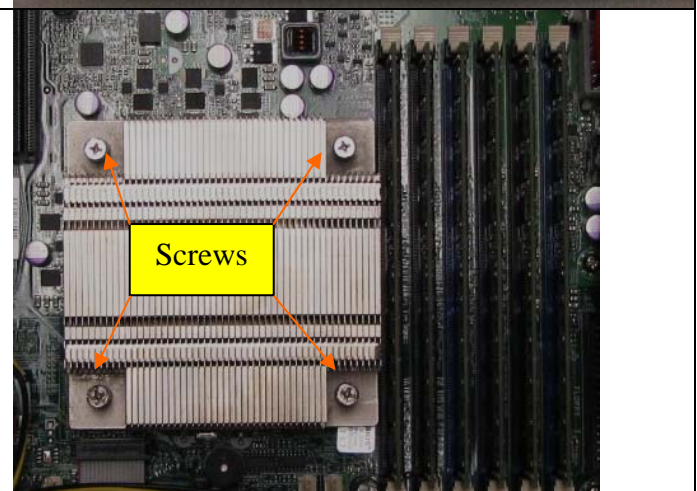

Title:

**Unit Disassembly for WEEE**

Document Number / Disk File:

597-786-1200-00

By:

Jegan Easwaram

Current Rev:

0A

Date:

12/27/11

Assemblies Covered:

**S-1200R3 (786-1200-00/01/02)**

10. Removal of the CPU
- Lift the CPU latch out and up to unfasten the CPU.
  - Carefully pick up the CPU on both sides and lift it off the board.
  - Discard the CPU into the appropriate Recycle Bin.**

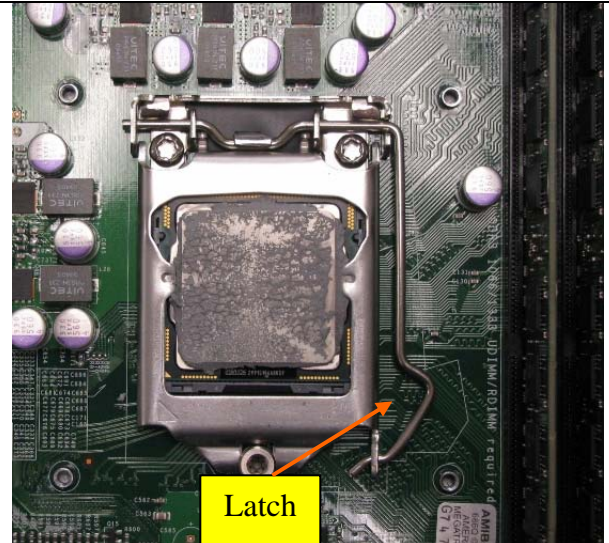

11. Removal of the memory DIMMs from the motherboard.
- Remove each of the memory DIMMs by pushing down and out on the two latches, one on each end of the DIMM connector. Lift memory DIMM straight out to remove.
  - Discard the memory DIMMs into the appropriate recycle bin.**

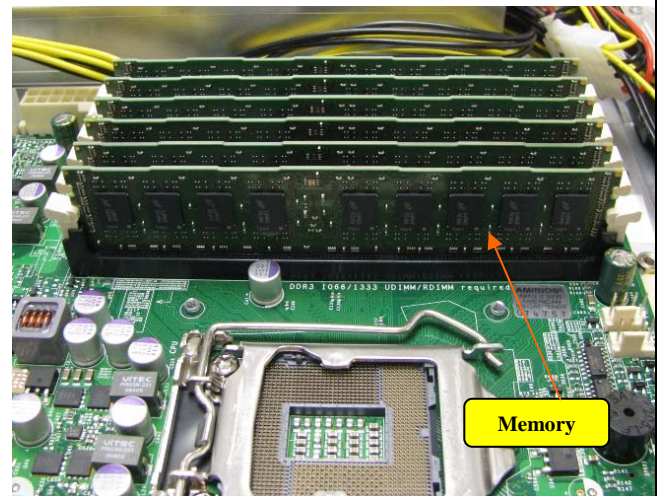

<b>NEI</b>	<b>Work Instruction</b>		Page 8 of 14
Title: <b>Unit Disassembly for WEEE</b>			
Document Number / Disk File: <b>597-786-1200-00</b>	By: Jegan Easwaram	Current Rev: 0A	Date: 12/27/11
Assemblies Covered: <b>S-1200R3 (786-1200-00/01/02)</b>			

12. Removal of the Battery from the motherboard.
- Remove the coin style Lithium Battery.
  - Discard the Lithium Battery into the appropriate recycle bin.**

**\*\*\* CAUTION \*\*\***  
**Care should be observed when disposing of the battery to avoid shorting it!**

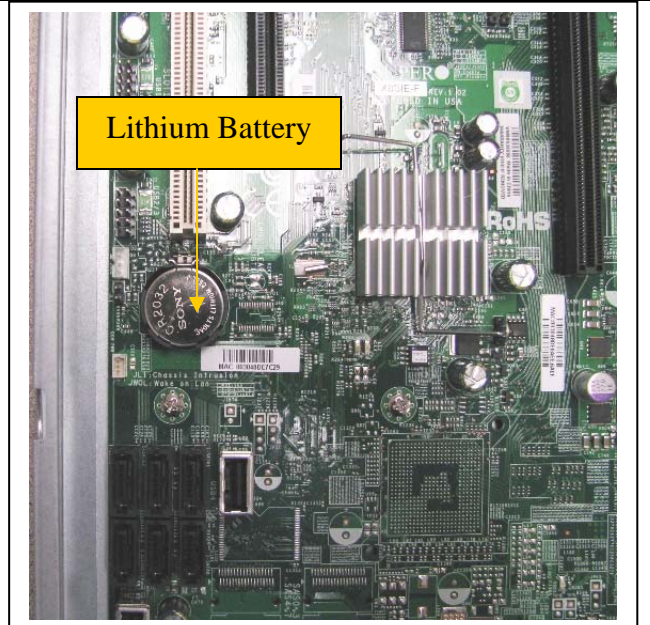

13. Removal of the Hard Drive or Solid State Drive requires a #2 Phillips screwdriver.
- Unscrew the four screws (bottom of the chassis) shown in the diagram.
  - Pull the Hard Drive or Solid State Drive out to complete removal.
  - Discard the hard drive and screws into the appropriate recycle bin**

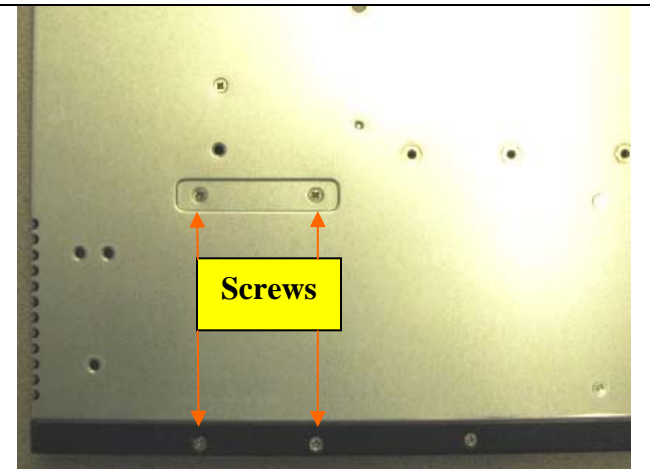



Title:

**Unit Disassembly for WEEE**

Document Number / Disk File:

597-786-1200-00

By:

Jegan Easwaram

Current Rev:

0A

Date:

12/27/11

Assemblies Covered:

**S-1200R3 (786-1200-00/01/02)**

17. Removal of the motherboard requires a #2 Phillips screwdriver.
- Ensure that all cables and connectors to the motherboard have been removed.
- Remove the seven (7) screws from the motherboard.
  - Remove the motherboard by sliding it towards the front of the unit to disengage it from the rear panel then lift motherboard out.
  - Discard the Motherboard and screws into the appropriate recycle bin.**

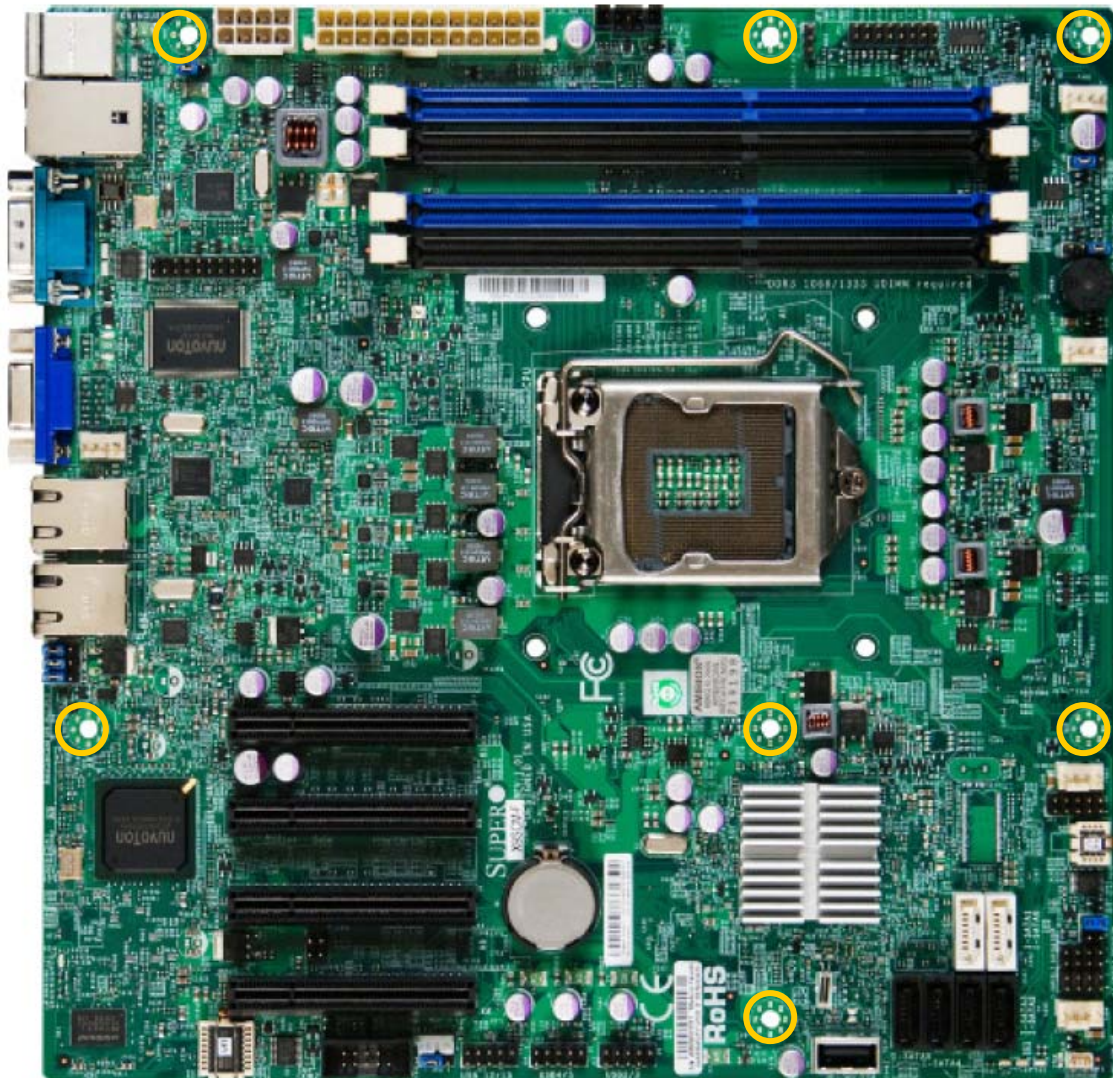

<b>NEI</b>	<b>Work Instruction</b>		Page 10 of 14
Title: <b>Unit Disassembly for WEEE</b>			
Document Number / Disk File: 597-786-1200-00	By: Jegan Easwaram	Current Rev: 0A	Date: 12/27/11
Assemblies Covered: <b>S-1200R3 (786-1200-00/01/02)</b>			

18. Removal of the LED controller requires a #1 Phillips screwdriver.
- Remove the three screws holding the LED controller.
  - Pull the controller out of the unit.
  - Discard the LED controller and screws into the appropriate recycle bin.**

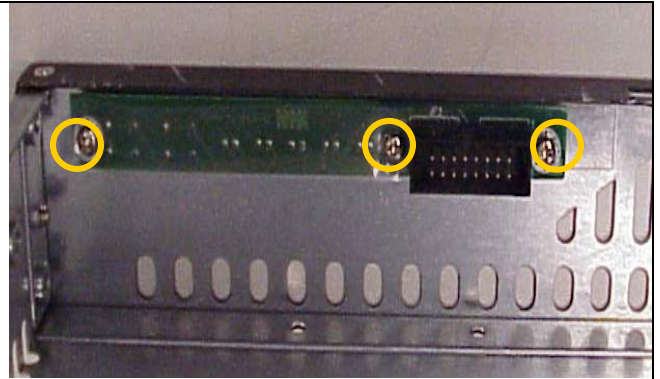

19. Removal of LCD if present requires #1 Phillips screwdriver.
- Remove the six screws (SMC LCD), or five screws (Crystal Fontz LCD) holding the LCD controller.
  - Pull the controller out of the unit.
  - Remove the hex nut holding the LED bracket to the chassis, and pull off.
  - Discard the LCD controller and screws, hex nut, and LED into the appropriate recycle bin.**

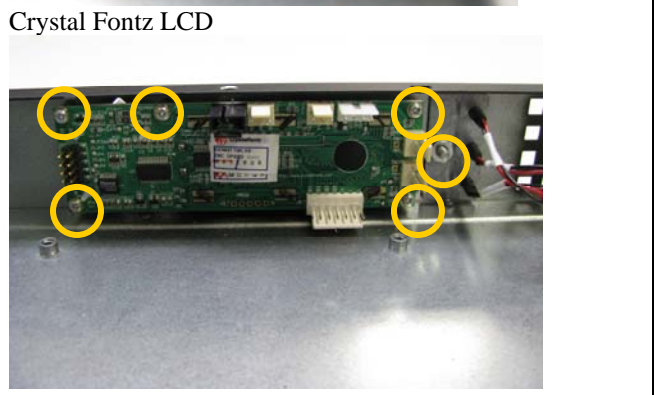
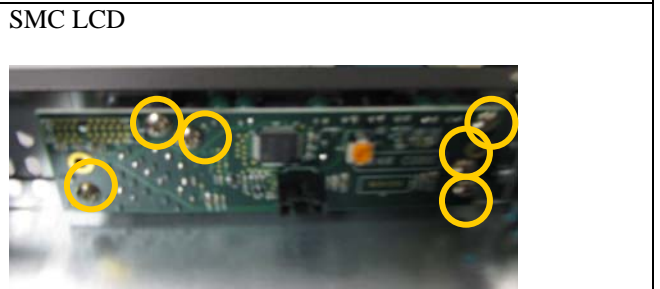

20. Removal of the power supply requires a #2 Phillips screwdriver.
- Remove the screw holding the power supply on the bottom of the chassis.
  - Remove the two screws remaining that mount the power supply to the chassis at the rear end of the unit.
  - Remove the power supply from the chassis by lifting up and out.
  - Discard the power supply and screws into the appropriate recycle bin.**

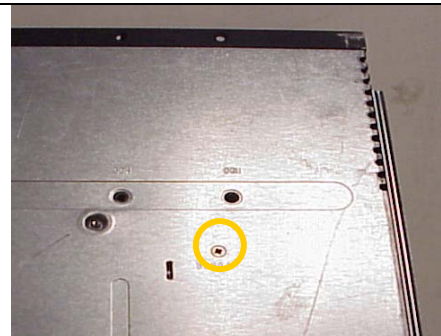

Title:

**Unit Disassembly for WEEE**

Document Number / Disk File:  
597-786-1200-00

By:  
Jegan Easwaram

Current Rev:  
0A

Date:  
12/27/11

Assemblies Covered:

**S-1200R3 (786-1200-00/01/02)**



Fully Disassembled Unit

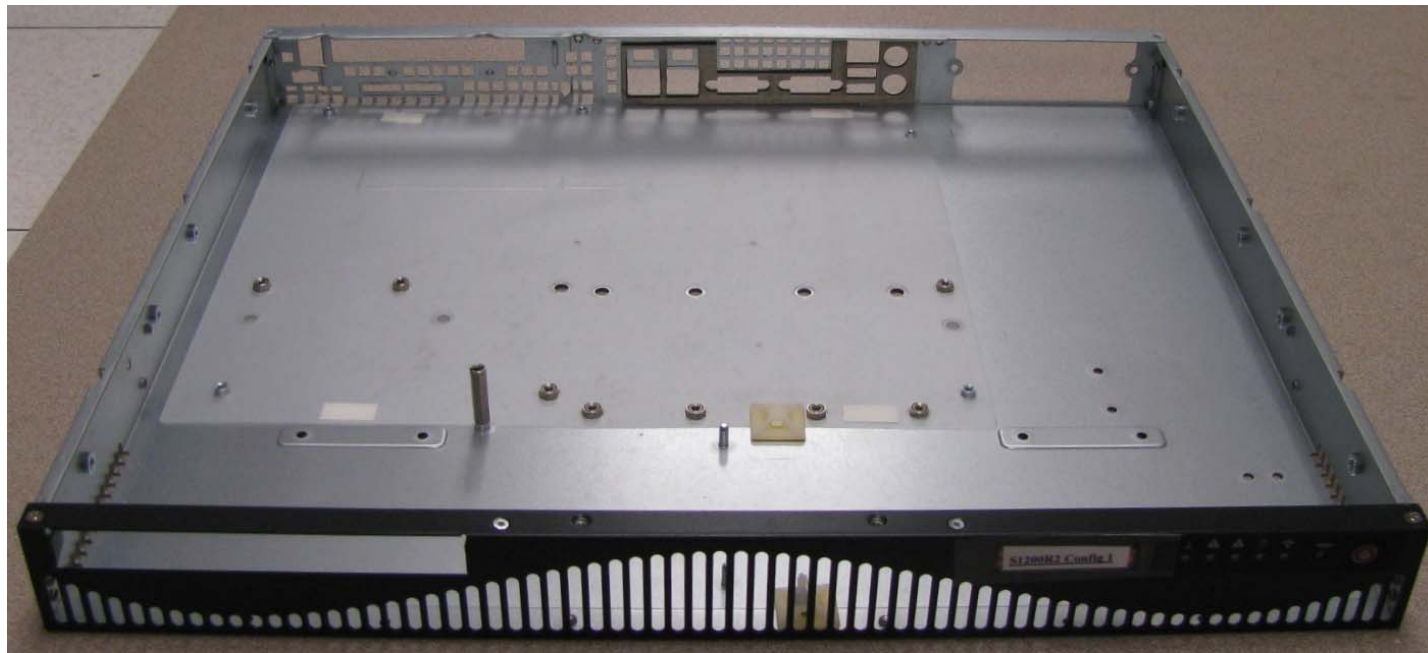

<b>NEI</b>	<b>Work Instruction</b>		Page 12 of 14
Title: <b>Unit Disassembly for WEEE</b>			
Document Number / Disk File: 597-786-1200-00	By: Jegan Easwaram	Current Rev: 0A	Date: 12/27/11
Assemblies Covered: <b>S-1200R3 (786-1200-00/01/02)</b>			

<b>Recycling/Material Code</b>	<b>Important Information</b>
<b>Material /Components, which must be removed and treated separately</b>	
Lithium Battery	Battery free of hazardous substances, installed in socket on the motherboard
Printed circuit boards	Motherboard, DIMMs, PCI card, PCI riser, Power Supply, DVD adapter PCB
Disk Drives	Hard Drive, DVD Drive, Solid State Drive
<b>Material /Components, which can disturb certain recycling processes</b>	
Aluminum	Heat sink, handles
<b>Material /Components, through which benefits can normally be achieved</b>	
Cold Rolled Steel	Top cover, chassis bottom, bezel, DVD-ROM mounting bracket, rails
* ABS	Pushbuttons, Shroud
Cables	Distributed in device
Fans	
<b>Special notes</b>	
* Flame retardant of plastics <b>does not</b> contain PBB and PBDE.	

<b>NEI</b>	<b>Work Instruction</b>		Page 13 of 14
Title: <b>Unit Disassembly for WEEE</b>			
Document Number / Disk File: <b>597-786-1200-00</b>	By: Jegan Easwaram	Current Rev: 0A	Date: 12/27/11
Assemblies Covered: <b>S-1200R3 (786-1200-00/01/02)</b>			

### Annex A

Producer:	<Company name, other on addressing the producer>
Scope of information sheet:	< Product category as in Annex IA of WEEE Directive, or type of equipment as in Annex 1B of WEEE Directive, or producer's Product Family, or single products identified by brand and model name >

Component or Material	Remarks / Location
Battery (internal *) containing Mercury (Hg)/ NiCad/Lithium/ Other	<b>Lithium battery ↓</b> <b>Located on the motherboard</b>
Backlighting lamps of LCD/TFT or similar screens containing Mercury (Hg)	<b>NONE</b>
Mercury (Hg) in other applications**	<b>NONE</b>
Cadmium**	<b>NONE</b>
Gas discharge lamps	<b>NONE</b>
Plastic containing ruminated flame retardants other than in Printed Circuit Assemblies ***	<b>NONE</b>
Liquid Crystal Displays with a surface greater than 100 cm <sup>2</sup>	<b>NONE</b>
Capacitors with PCB's	<b>NONE</b>
Capacitors with substances of concern**** + height > 25 mm, diameter > 25 mm or proportionately similar volume	<b>NONE</b>
Asbestos	<b>NONE</b>
Refractory ceramic fibres	<b>NONE</b>
Radio-active substances	<b>NONE</b>
Beryllium Oxide	<b>NONE</b>
Other forms of Beryllium	<b>BE-CU in some connector ↓</b> <b>contacts</b>
Gasses - which fall under Regulation (EC) 2037/2000 and all hydrocarbons (HC).	<b>NONE</b>
Components with pressurised gas which need special attention (Pressure > 1,5 bar) *****	<b>NONE</b>
Liquids ***** if volume > 10 cl (or equivalence in weight, e.g. for PCB, oil...)	<b>NONE</b>
Mechanical components that store mechanical energy (i.e. springs) or equivalent parts which need special attention ***** (diameter > 10 mm and height > 25 mm or proportionally similar volume and expanding)	<b>NONE</b>

<b>NEI</b>	<b>Work Instruction</b>		Page 14 of 14
Title: <b>Unit Disassembly for WEEE</b>			
Document Number / Disk File: <b>597-786-1200-00</b>	By: <b>Jegan Easwaram</b>	Current Rev: <b>0A</b>	Date: <b>12/27/11</b>
Assemblies Covered: <b>S-1200R3 (786-1200-00/01/02)</b>			

↓ = Arrow indicates the need for the location of the compartment/ substances within the product. When the location of a substance/ components is requested, it is at part level, e.g. main board, housing etc

\* Internal means that batteries can only be removed by opening the product by means of (a) tool(s).

\*\* Substances are considered to be in the product if present above the levels specified in Commission Decision 2005/618/EC related to Directive 2002/95 (EC) (RoHS Directive) or if their use is permitted through exemptions in the Annex of Directive 2002/95(EC)

\*\*\* To be coherent with industry current standards and practices on tracking of plastic parts, Directive 2002/96 (EC) Annex II requirement is understood to focus on plastic parts that weight more than 25 g.

\*\*\*\* Substance of concern other than PCB, to be specified/ addressed further in the context of Directive 2002/96 (EC) Annex II national requirements and European developments

\*\*\*\*\* Needs of equivalent nature as those for maintenance, service manuals and installation for safety purposes.